



认证	UL  	
电气性能		
参考标准	UL	IEC
额定电压	150V	250V
额定电流	4A	5A
额定冲击电压	2.5KV	
机械性能		
温度范围	-40℃~+105℃	
尺寸		
间距	2.5mm(.098")	
极数	2P-12P	
材质和电镀		
塑件	PA66,UL94V-0	
焊针	黄铜,镀锡	



订购方式:

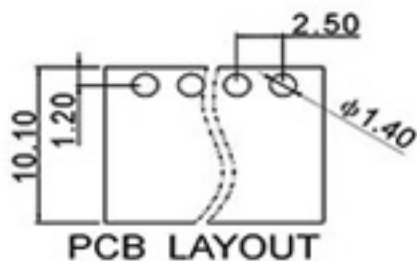
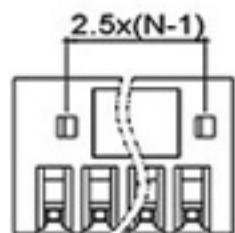
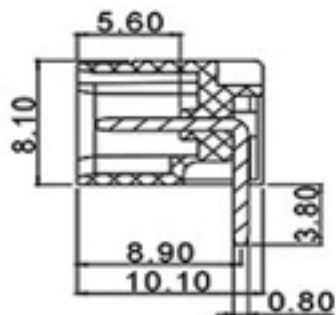
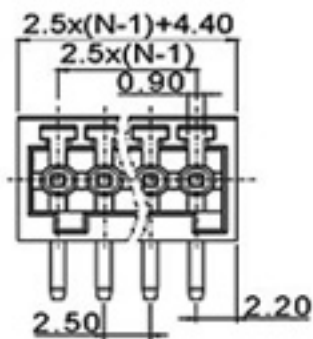
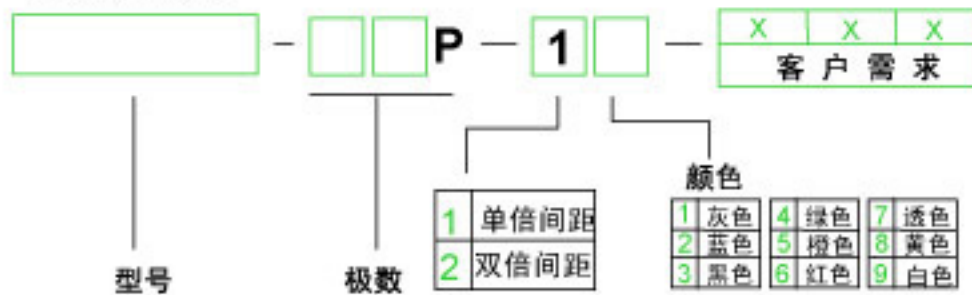
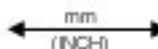

 mm (INCH)	 中国·康伟电子有限公司 NAME 15EDGRC-2.5
